







CL.1 Deck valve clockwise closing cold - Brushed Platinum

CL.1

20 002 705

- with CASCADE structure
- hole diameter 32 mm
- rosette 60 x 60 mm
- with cold marking



| | | |
|---|-------------------------------|---------------|
|  | Brushed Platinum | 20 002 705-06 |
|  | Chrome | 20 002 705-00 |
|  | Dark Chrome | 20 002 705-19 |
|  | Brushed Champagne (22kt Gold) | 20 002 705-46 |
|  | Champagne (22kt Gold) | 20 002 705-47 |
|  | Brushed Dark Platinum | 20 002 705-99 |

20 002 705

mm [inches]

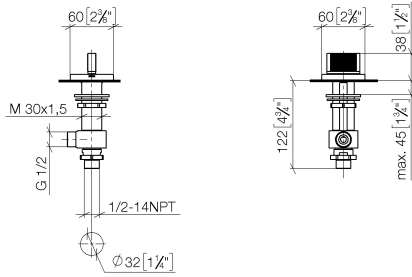

Flow rate chart



Certificates

IAPMO_4976 (5). WRAS_2103001. LGA_28688.

20 002 705

Parts for other finishes can be found here: [Chrome](#)

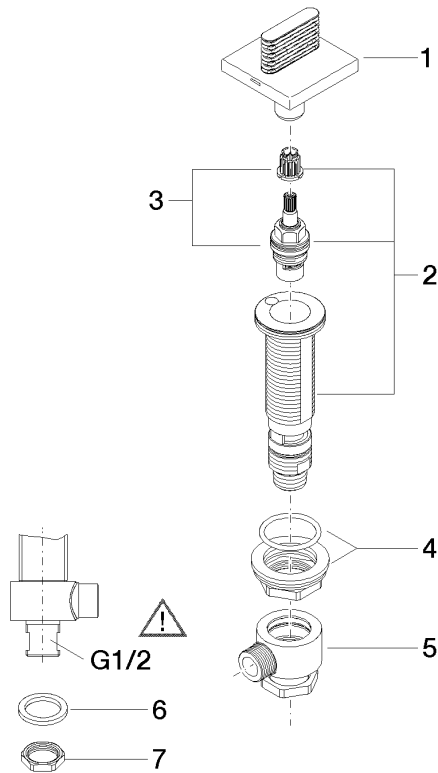

Spare parts list

| No. | Item Number | Name | Quantity used | Delivery time |
|-----|--------------------|--------------------|---------------|---------------|
| 1 | 90 20 70 053 04-06 | handle (cold) | 1 | 10 |
| 2 | 04 17 11 058 33 90 | side panel | 1 | 2 |
| 3 | 90 90 03 133 00 90 | top | 1 | 2 |
| 4 | 04 23 10 032 78 90 | fixing set | 1 | 2 |
| 5 | 04 17 11 023 10 90 | distributor | 1 | 2 |
| 6 | 90 23 30 040 00-06 | threaded connector | 1 | 10 |
| 7 | 09 30 11 059 90 | disc | 1 | 2 |
| 8 | 09 23 10 012 90 | nut | 1 | 2 |